

מתחזקו בין איורים שמסתיימים באותו צליל סוגר:

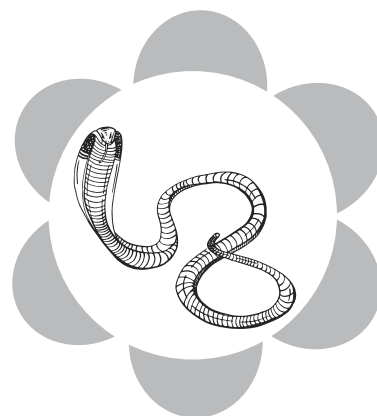

מתחזקו קו בין איורים שמסתימים באותו צליל סוגר:

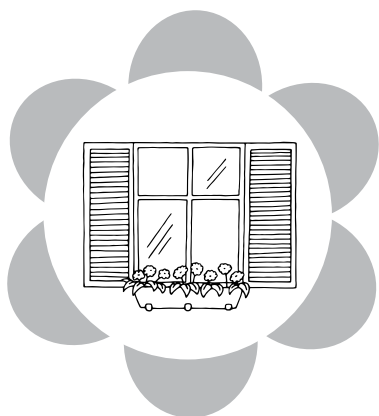
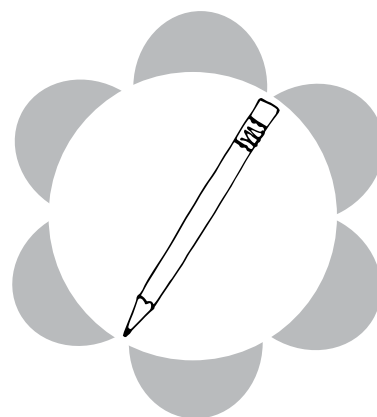
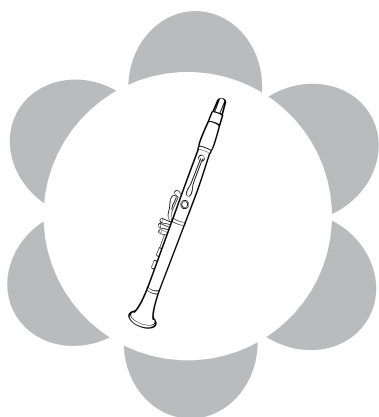
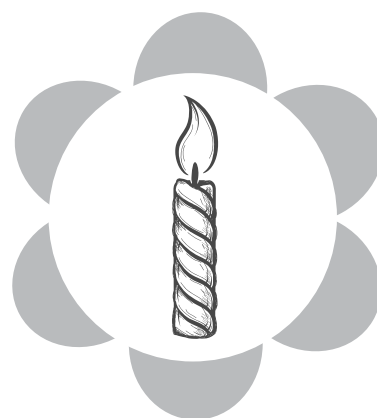
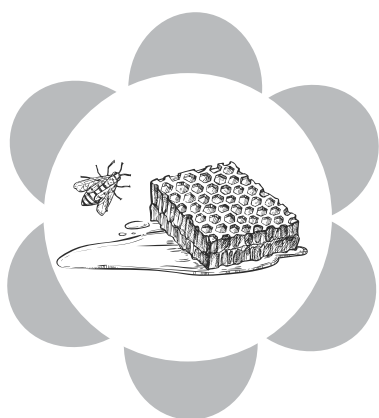
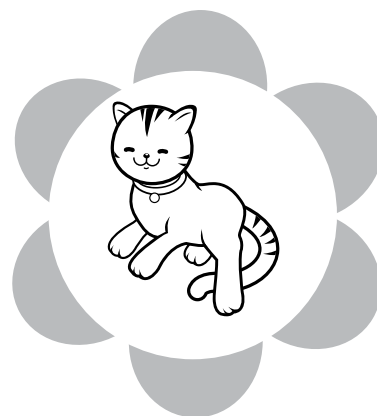
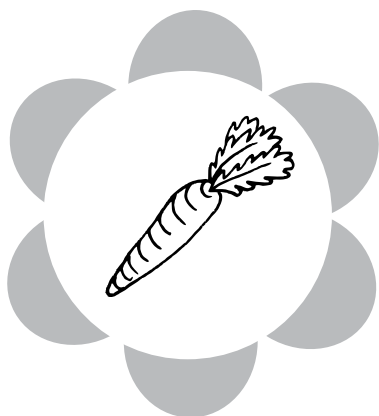
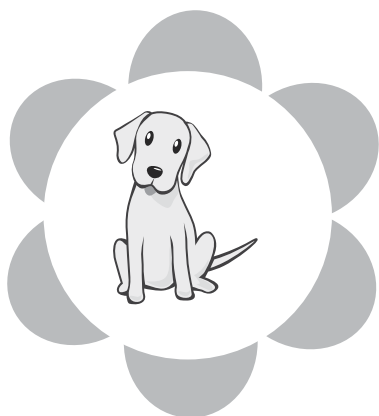
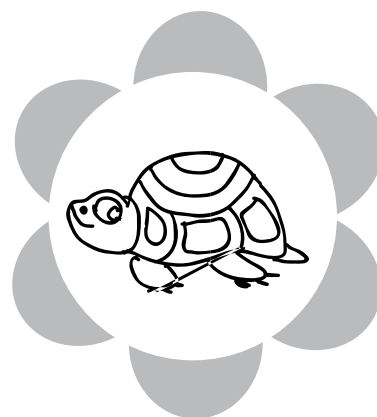
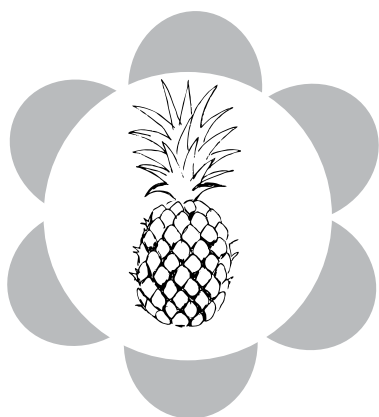
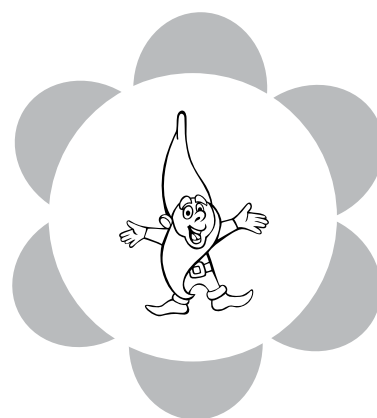
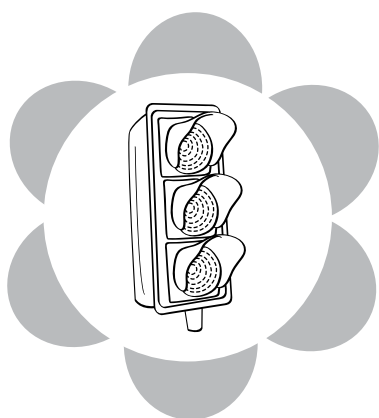
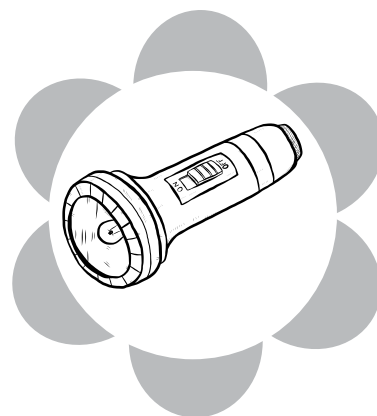
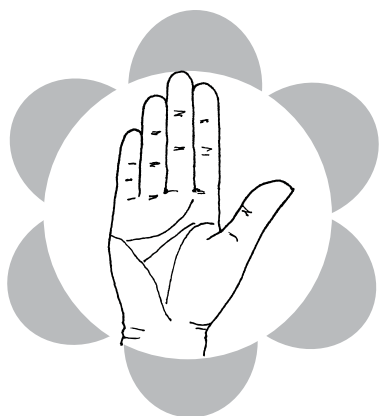

צְבְעוּ רַק אֵיזוֹרִים שְׁמִסְתִּימִים בְּצֵלִיל ל:

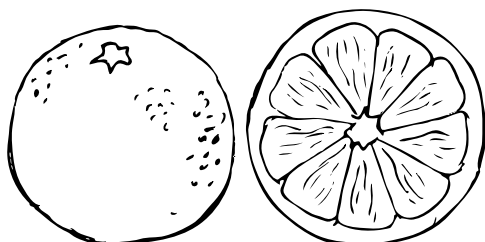
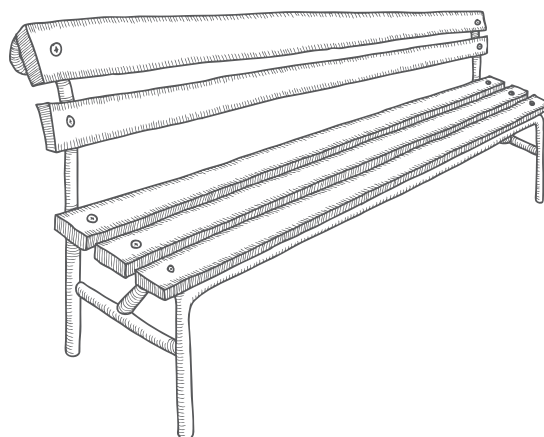
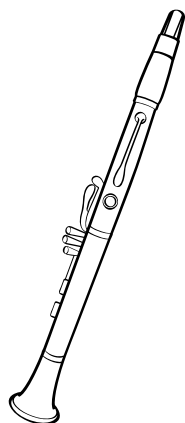
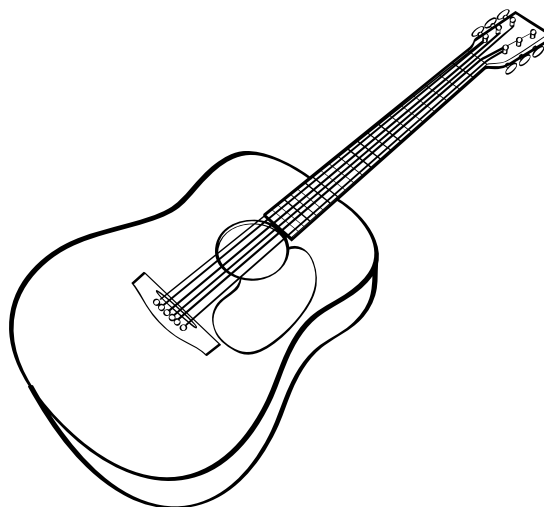
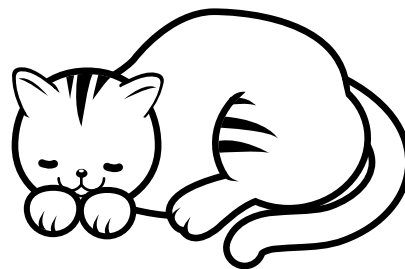
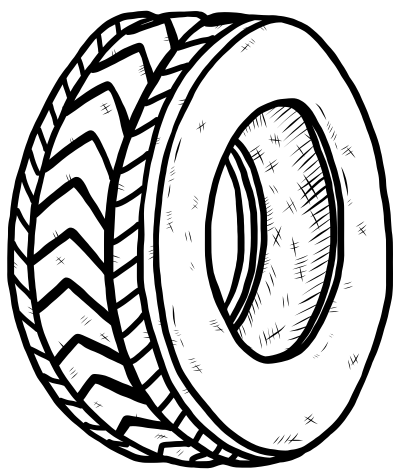

האיזורים הם: חתול, גלגל, גיטרה, נעל, חליל, כלב, ספסל, תפוז.

צָבְעוּ רַק בְּעָלֵי מְקָצוּעַ שְׁשִׁמוּתֵיהֶם מִסְתִּימִים בַּצָּלִיל ר:



הקיפו בַּצֵּבַע אָדָם אֵינֹרִים שְׁמֶסֶתִימִים בַּצֵּלִיל ג:

הקיפו בַּצֵּבַע יָרֵק אֵינֹרִים שְׁמֶסֶתִימִים בַּצֵּלִיל ש:

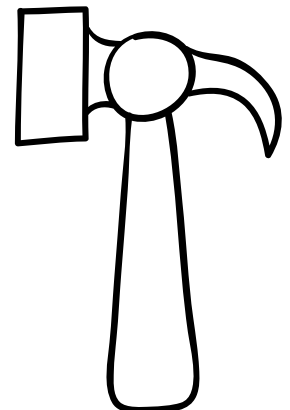
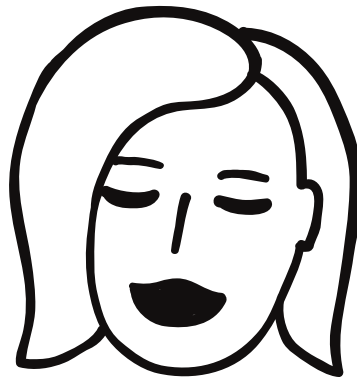
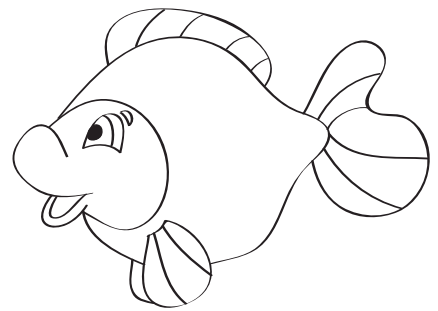
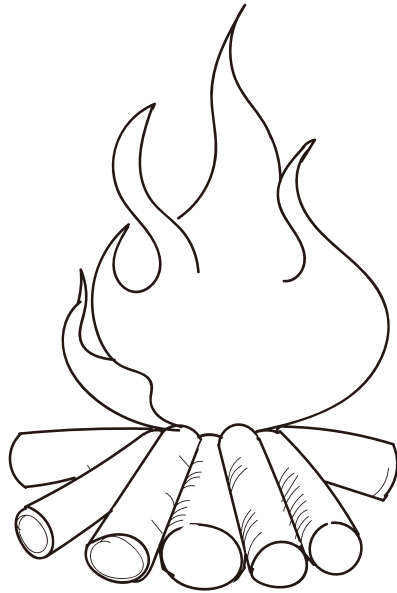

הקיפו בַּצָּבֶע **כָּחֹל** אֵיוֹרִים שְׁמִסְתִּימִים בַּצְּלִיל **ת**:

הקיפו בַּצָּבֶע **יָרֵק** אֵיוֹרִים שְׁמִסְתִּימִים בַּצְּלִיל **ס**:

