

מה שומעים בתחלת המלה?

צבעו את הצלילים אַ אָ אֵ.
צבעו רק איורים שמתחילים בצליל זה.

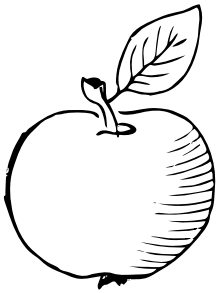
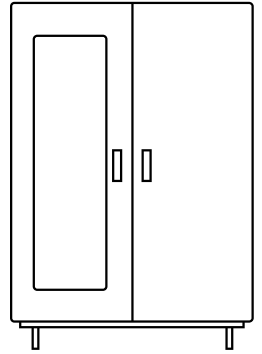
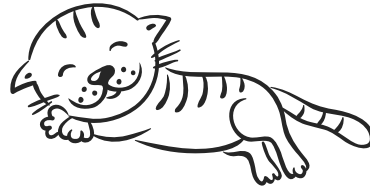
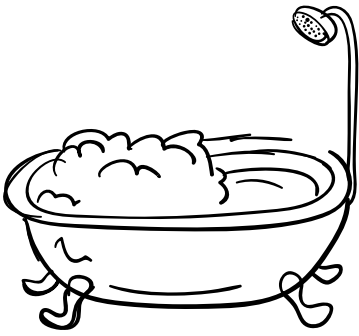

אֵ

אָ

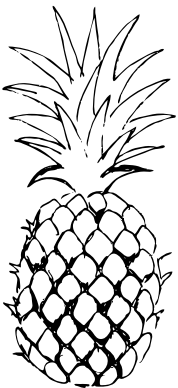
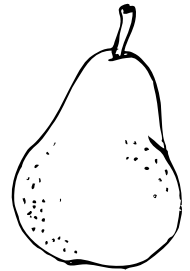

אַ

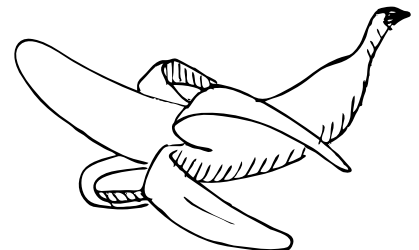
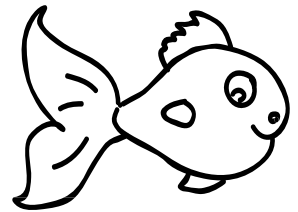

מה שומעים בתחלת המלה?

צבעו את הצלילים **ש** **ש**.
צבעו רק איורים שמתחילים בצליל זה.

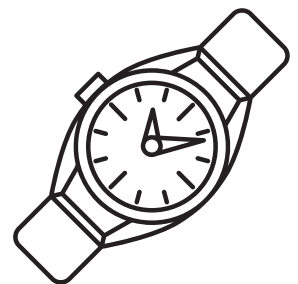
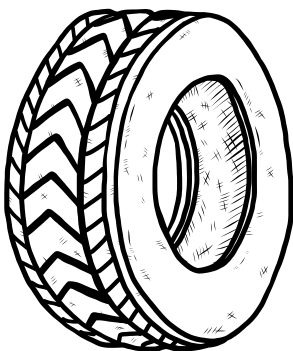
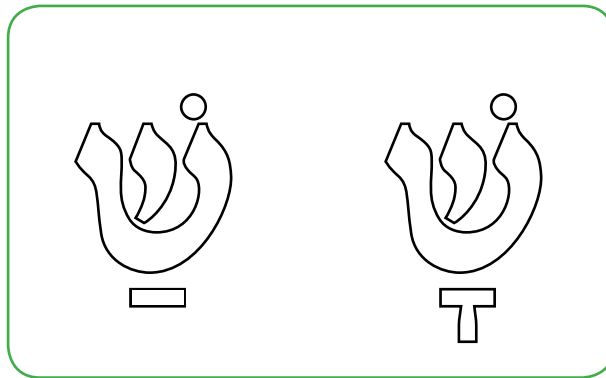
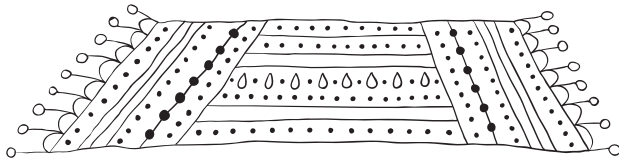

מה שומעים בתחלת המלה?

צבעו את הצלילים ל. ל.
צבעו רק איורים שמתחילים בצליל זה.

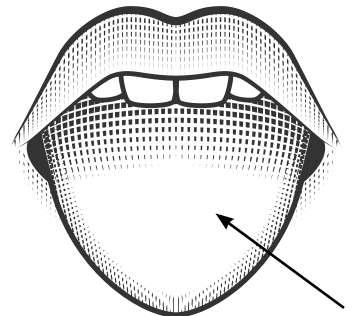
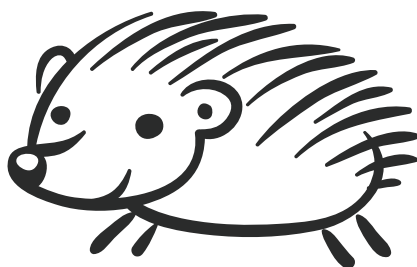
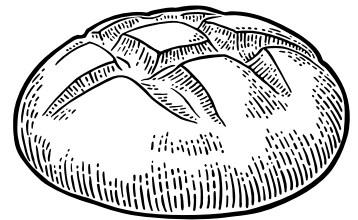
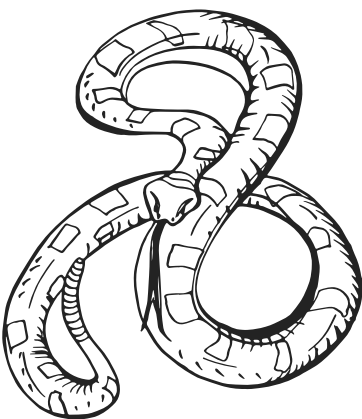
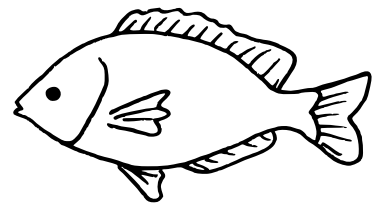
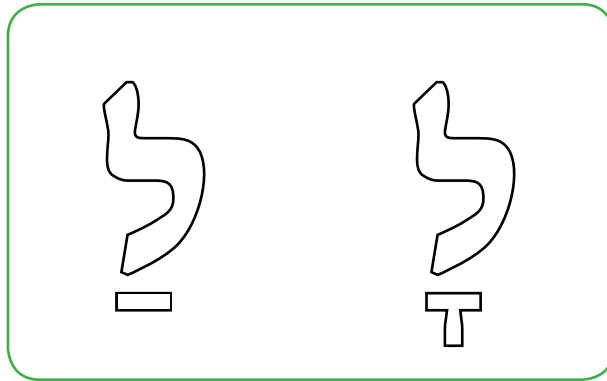
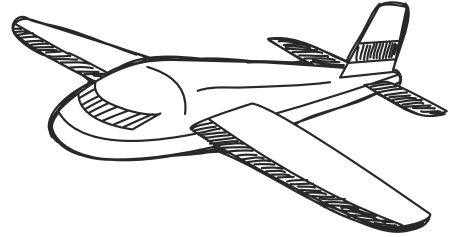
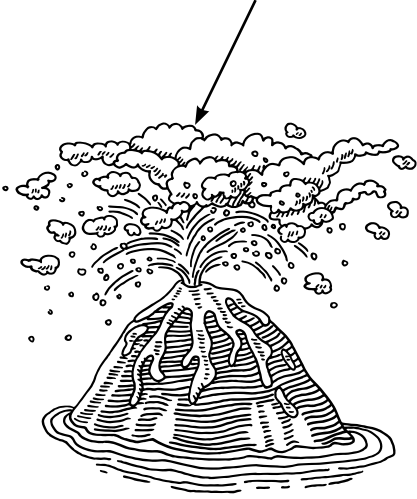

מה שומעים בתחלת המלה?

צבעו את הצלילים **ר** **ר**.
צבעו רק איורים שמתחילים בצליל זה.

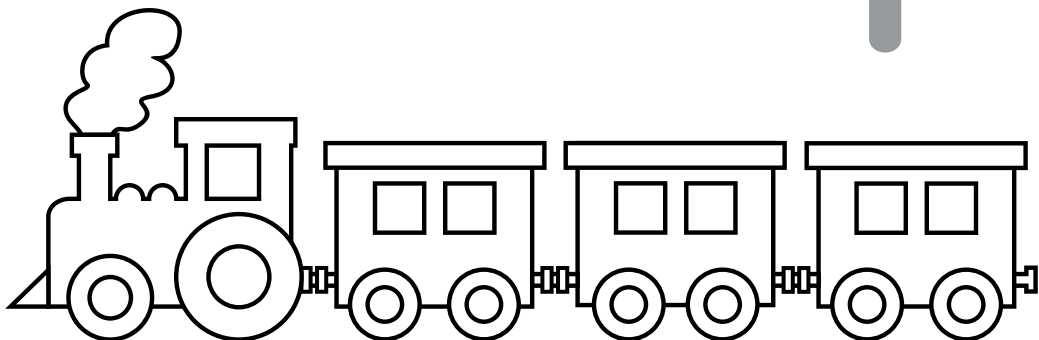
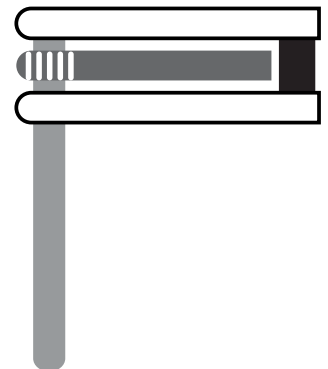
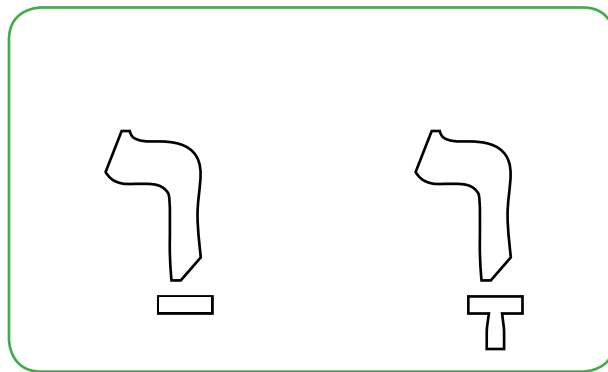
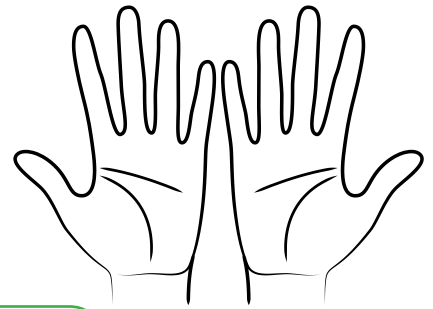
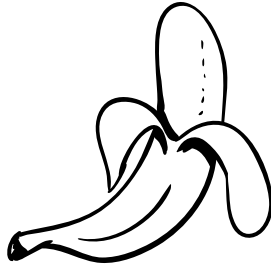
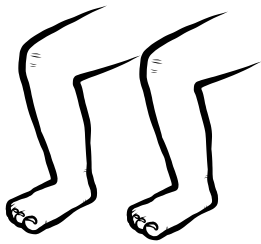

מה שומעים בתחלת המלה?

צבעו את הצלילים **ב** **ב**.
צבעו רק איורים שמתחילים בצליל זה.

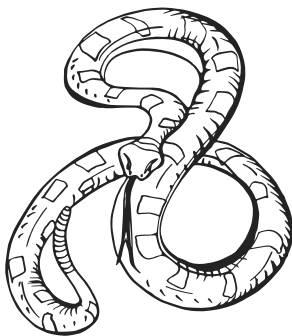
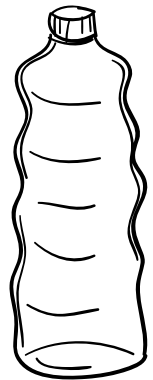
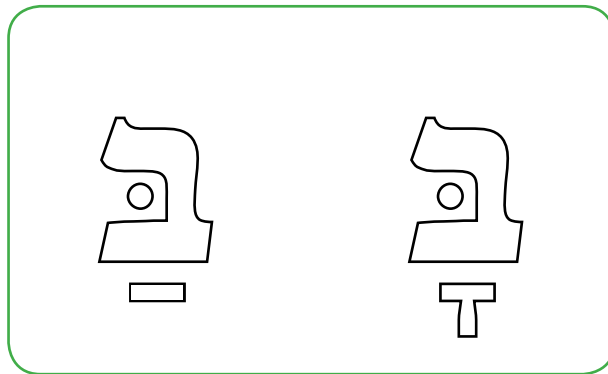
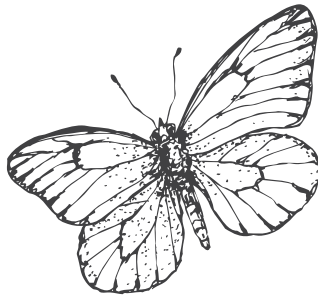
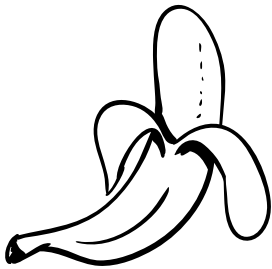

מה שומעים בתחלת המלה?

צבעו את הצלילים **ג** **ג**.
צבעו רק איורים שמתחילים בצליל זה.

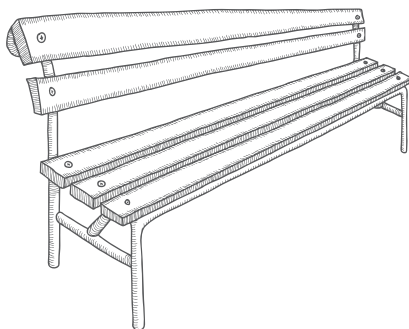
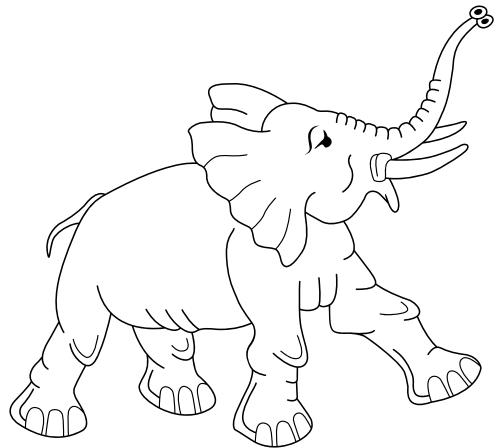
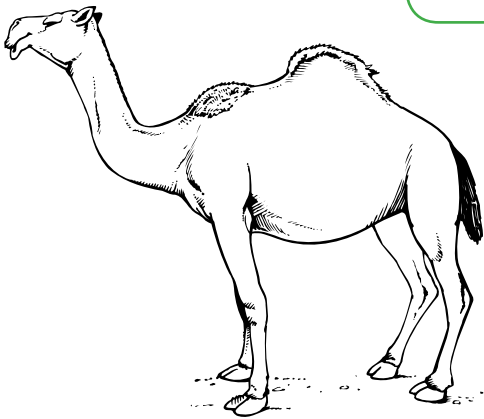
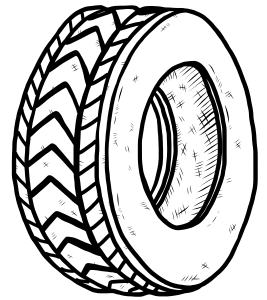
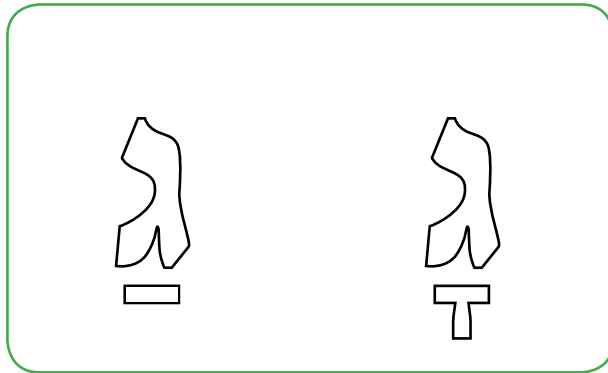
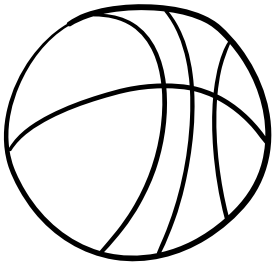
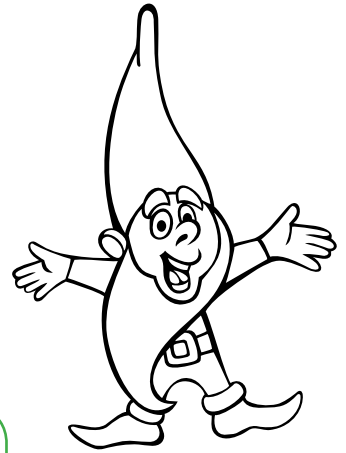
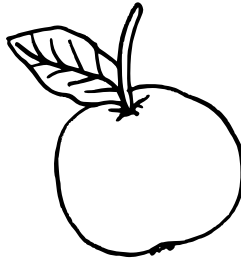
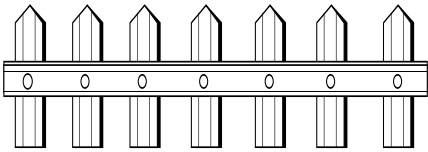

מה שומעים בתחלת המלה?

צבעו את הצלילים **ת ת ת**.
צבעו רק איורים שמתחילים בצליל זה.

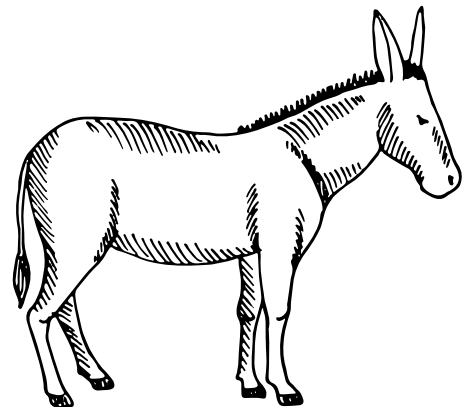
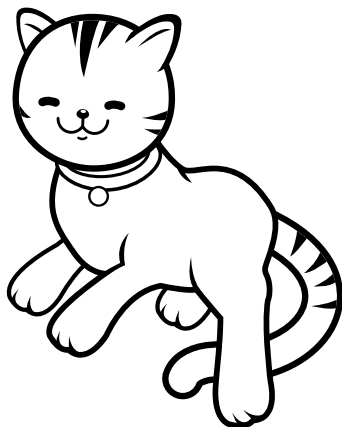
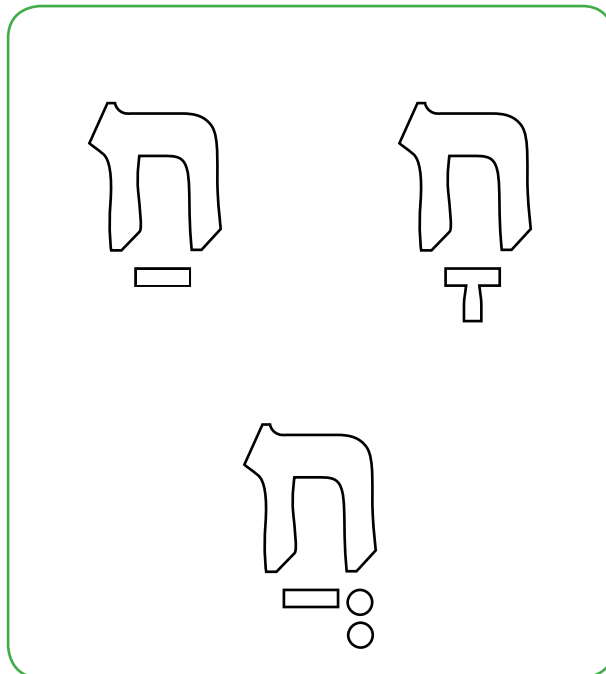
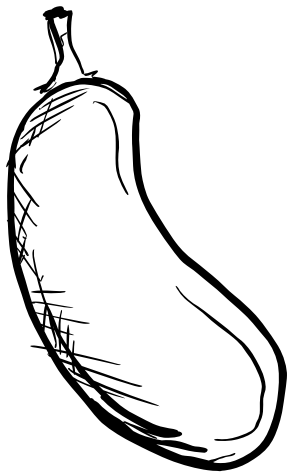
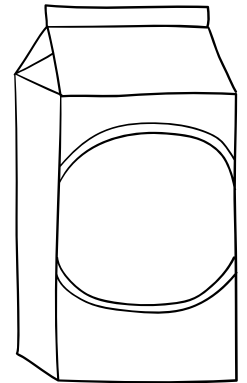
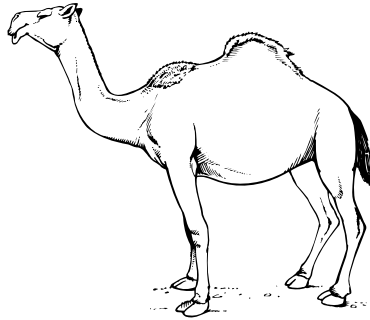
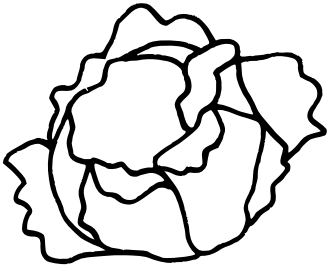

האיורים הם: חתול, כלב, חמור, גמל, חלב, חסה, חציל, פרפר.

מה שומעים בתחלת המלה?

צבעו את הצלילים **ת** **ת**.
צבעו רק איורים שמתחילים בצליל זה.

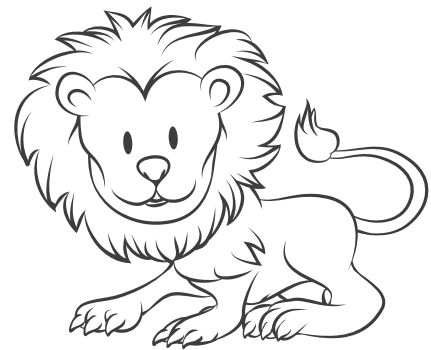
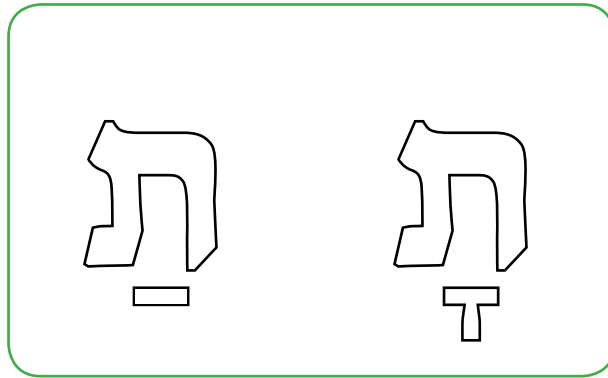
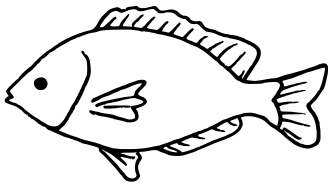
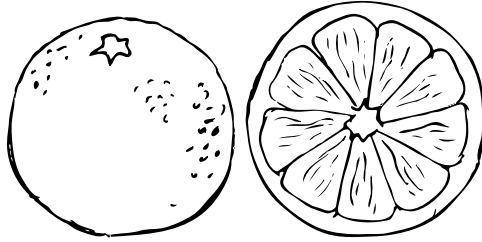
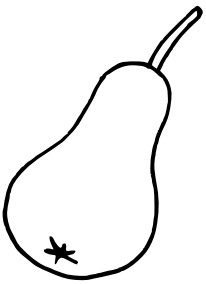

מה שומעים בתחלת המלה?

צבעו את הצלילים ס ס.
צבעו רק איורים שמתחילים בצליל זה.

