

הַשְּׁלִימוּ אֶת הַנְּקוּד מֵתַחַת לְכֹל צָלִיל פּוֹתֵחַ אוֹ □ □ □ □ 

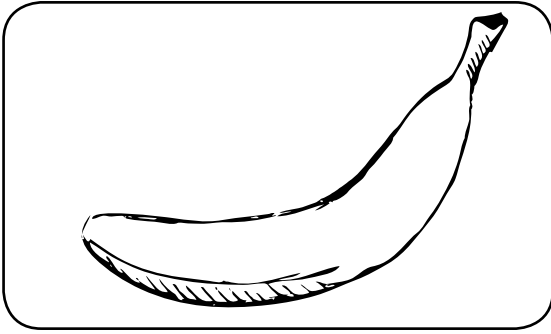

ב

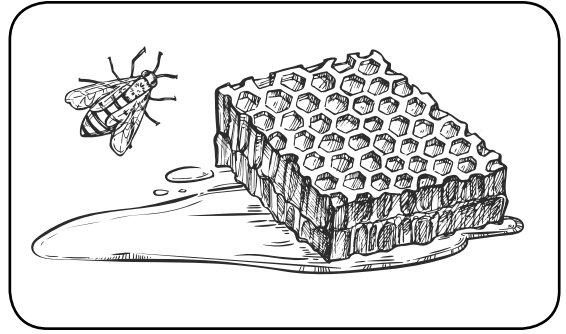

ד

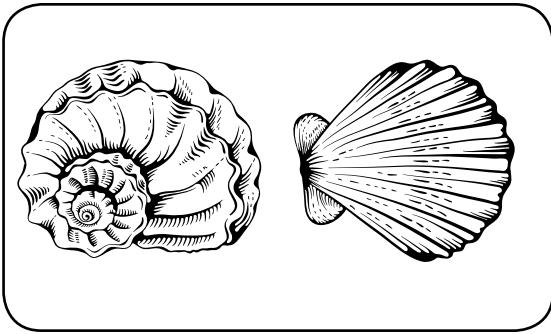

צ

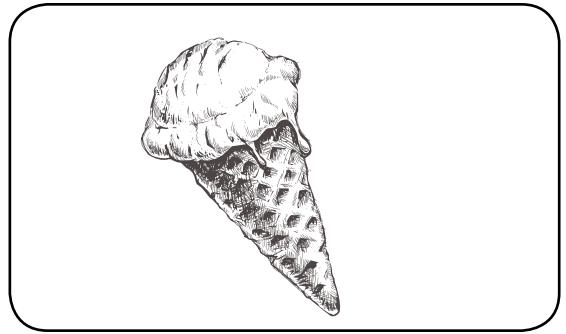

ג

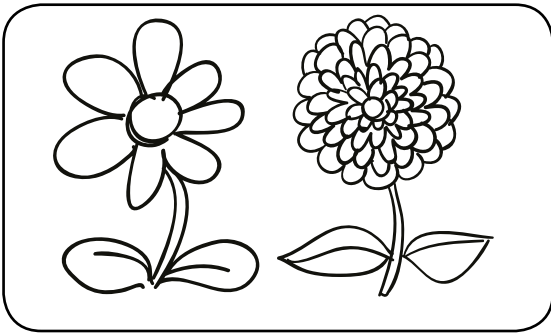

פ

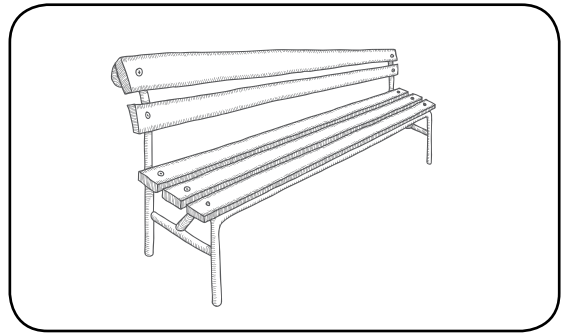

ס

האיורים הם: דבש, בננה, גלידה, צדפים, ספסל, פרחים.

הַשְּׁלִימוּ אֶת הַנְּקוּד מֵתַחַת לְכָל צָלִיל פּוֹתֵחַ אוֹ 

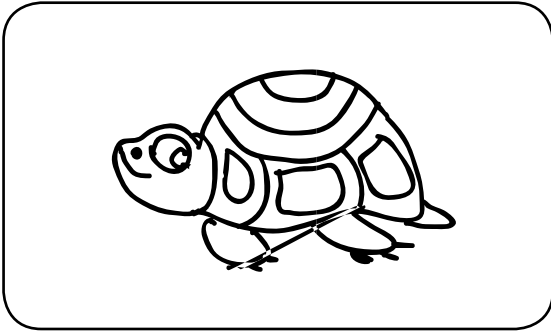

צ

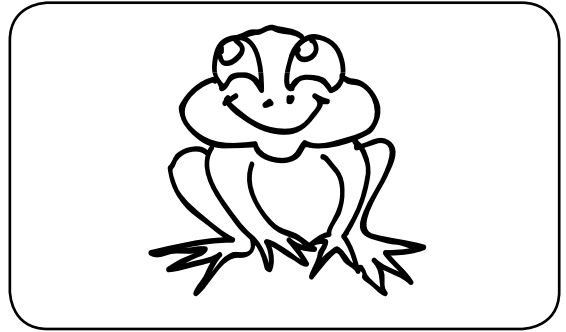

צ

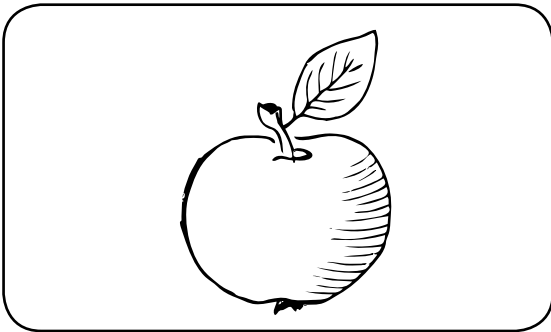

ת

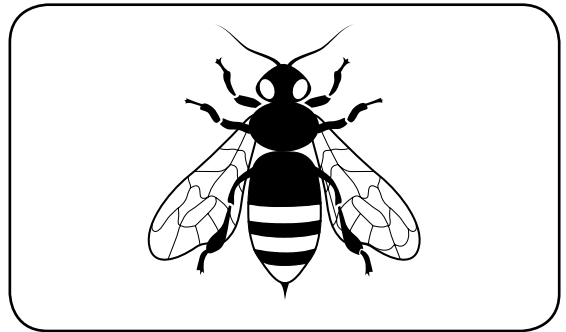

ד

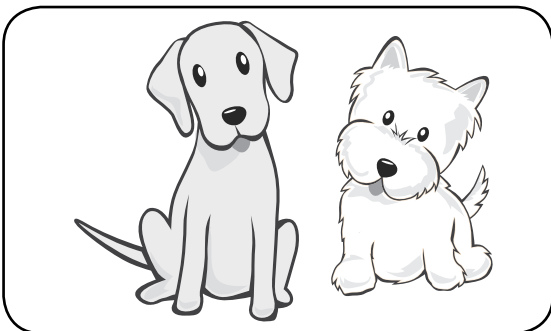

כ

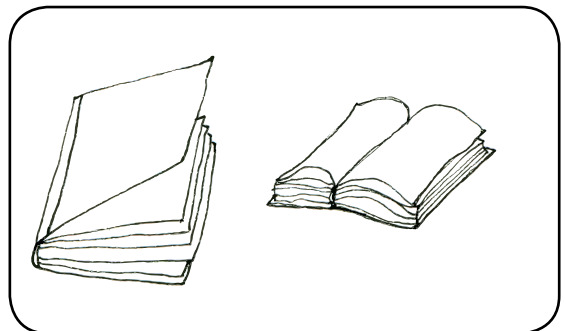

ס